

Bestelstaat Mavobox stekkenbak



Aanbevolen wordt de bestelstaat in te vullen met gebruik van Adobe Reader

Bedrijfsnaam: _____ Project: _____

Beugeltype S

Artikelcode:
1110 N Ø 8
1111 N Ø 10
1112 N Ø 12
1130 TP Ø 8
1131 TP Ø 10
1132 TP Ø 12
1140 TW Ø 8
1141 TW Ø 10
1142 TW Ø 12

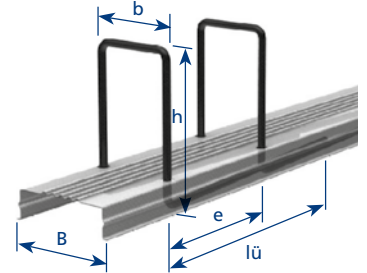
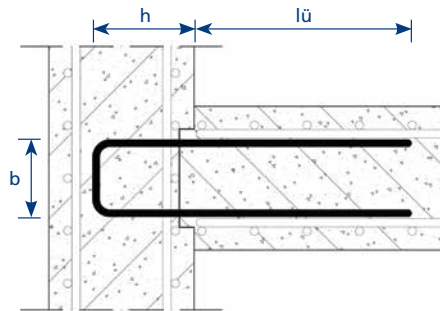

Beugeltype B

Artikelcode:
1113 N Ø 8, Ø 10 en Ø 12
1133 TP Ø 8, Ø 10 en Ø 12
1143 TW Ø 8, Ø 10 en Ø 12

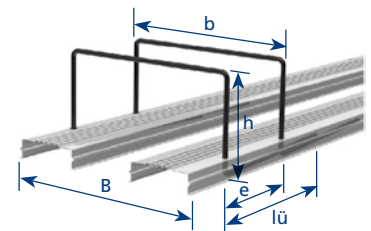
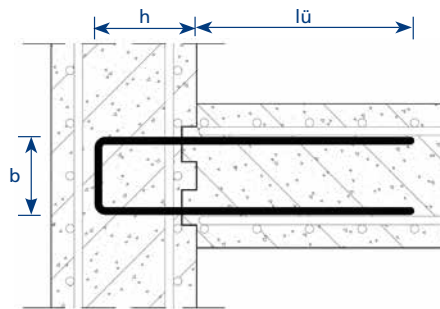

Beugeltype 2H

Artikelcode:
1120 N Ø 8
1121 N Ø 10
1122 N Ø 12
1180 TP Ø 8, Ø 10 en Ø 12
1160 TW Ø 8, Ø 10 en Ø 12

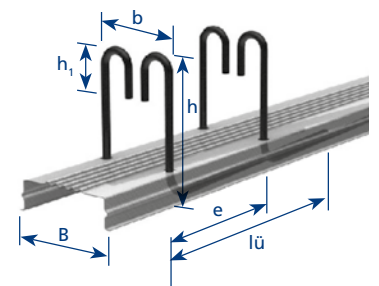
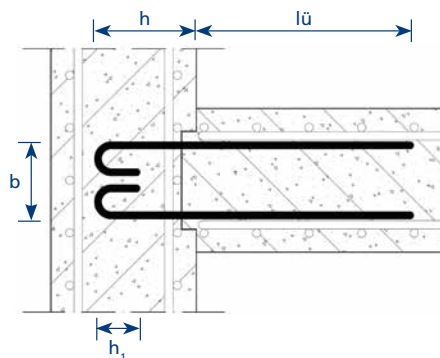

Beugeltype 2W

Artikelcode:
1123 N Ø 8, Ø 10 en Ø 12
1181 TP Ø 8, Ø 10 en Ø 12
1161 TW Ø 8, Ø 10 en Ø 12

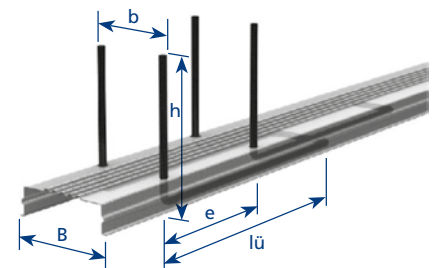
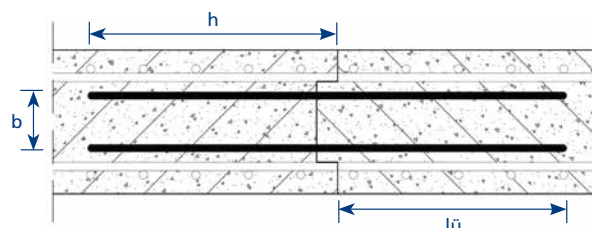

Aan deze documentatie kunnen geen rechten worden ontleend.
Wijzigingen voorbehouden.

Uitgave: nr 13, d.d. 30-09-2024

Bestelstaat Mavobox stekkenbak

Bedrijfsnaam: _____ Project: _____

Beugeltype WS

Artikelcode:
1100 N Ø 8
1101 N Ø 10
1102 N Ø 12
1170 TP Ø 8, Ø 10 en Ø 12
1150 TW Ø 8, Ø 10 en Ø 12

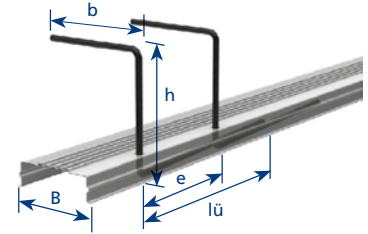
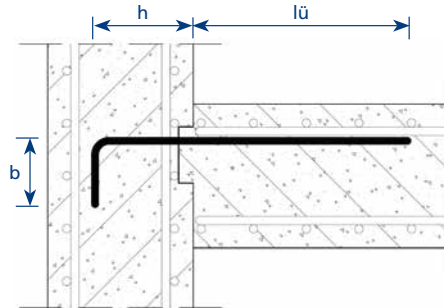

Beugeltype WH

Artikelcode:
1103 N Ø 8, Ø 10 en Ø 12
1171 TP Ø 8, Ø 10 en Ø 12
1151 TW Ø 8, Ø 10 en Ø 12

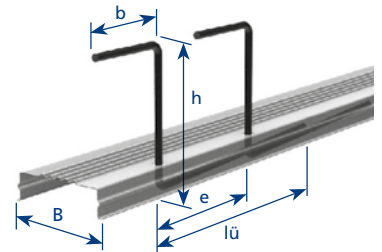
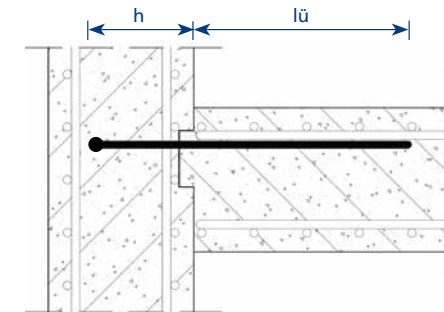

Beugeltype H

Artikelcode:
1104 N Ø 8, Ø 10 en Ø 12
1172 TP Ø 8, Ø 10 en Ø 12
1152 TW Ø 8, Ø 10 en Ø 12

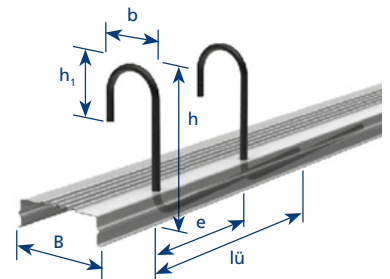
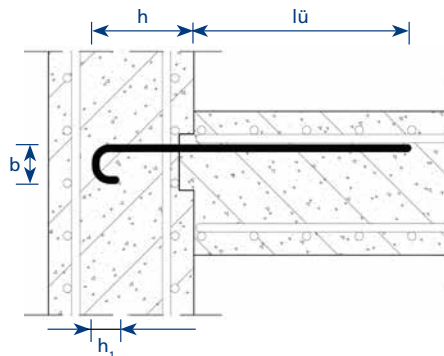

Beugeltype W

Artikelcode:
1105 N Ø 8, Ø 10 en Ø 12
1173 TP Ø 8, Ø 10 en Ø 12
1153 TW Ø 8, Ø 10 en Ø 12

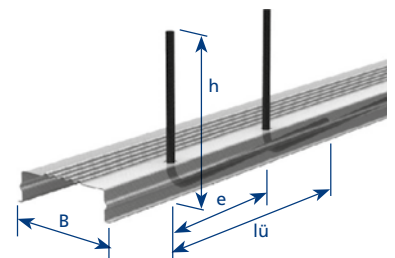
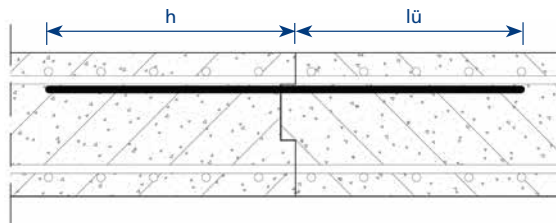

Beugeltype BA

Artikelcode:
1106 N Ø 8, Ø 10 en Ø 12
1174 TP Ø 8, Ø 10 en Ø 12
1154 TW Ø 8, Ø 10 en Ø 12

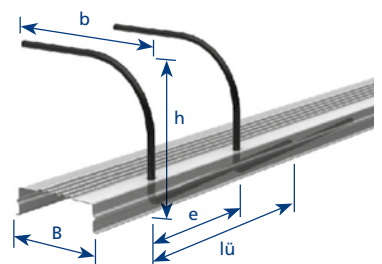
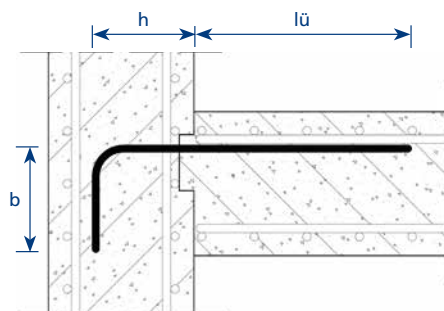

Aan deze documentatie kunnen geen rechten worden ontleend. Wijzigingen voorbehouden.

Uitgave: nr 13, d.d. 30-09-2024

Bestelstaat Mavobox stekkenbak (voor nokken en penanten)

Bedrijfsnaam: _____ Project: _____

Beugeltype BK

Artikelcode:
1114 N Ø 8, Ø 10 en Ø 12
1134 TP Ø 8 en Ø 10
1144 TW Ø 8 en Ø 10

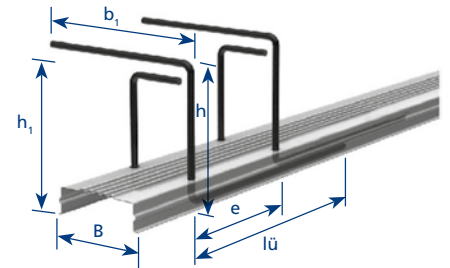
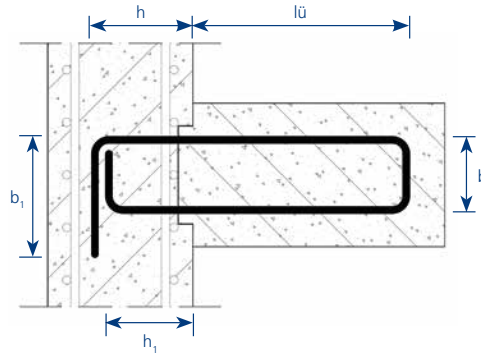

Beugeltype K

Artikelcode:
1115 N Ø 8, Ø 10 en Ø 12
1135 TP Ø 8 en Ø 10
1145 TW Ø 8 en Ø 10

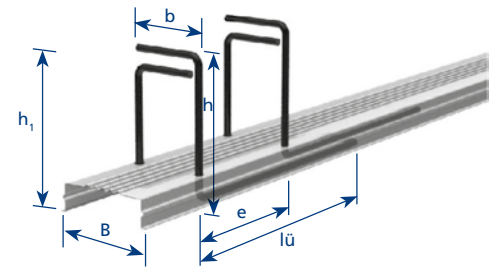
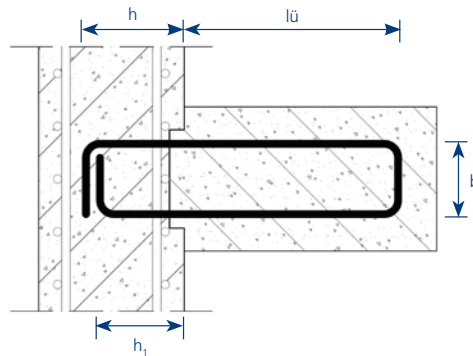

Beugeltype KO

Artikelcode:
1116 N Ø 8, Ø 10 en Ø 12
1136 TP Ø 8, Ø 10 en Ø 12
1146 TW Ø 8, Ø 10 en Ø 12

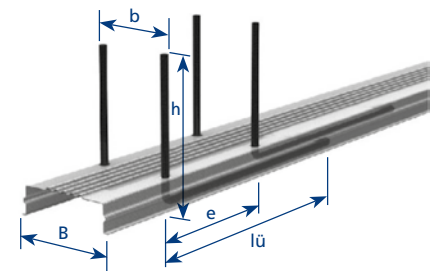
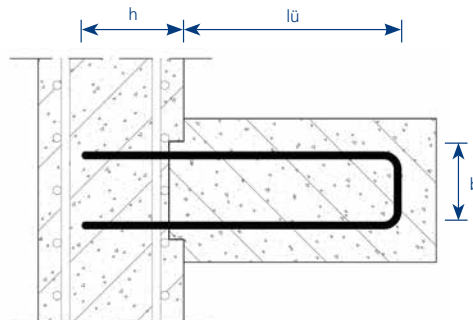

Beugeltype KH

Artikelcode:
1117 N Ø 8, Ø 10 en Ø 12
1137 TP Ø 8, Ø 10 en Ø 12
1147 TW Ø 8, Ø 10 en Ø 12

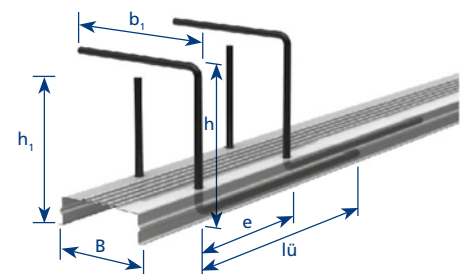
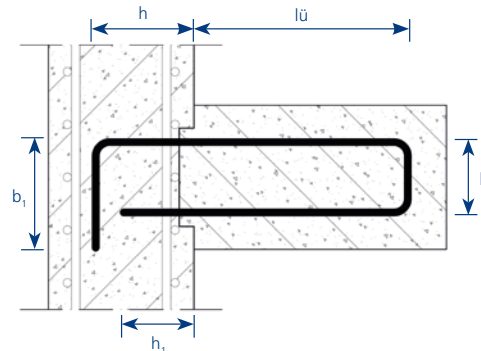

Bij de Mavobox voor nokken (type BK, K, KO en KH) worden de eerste 1 of 2 beugels uitgevoerd als stekken en worden de beugels los meegeleverd. De beugels hebben geen conische vorm.

Aan deze documentatie kunnen geen rechten worden ontleend.
Wijzigingen voorbehouden.

Uitgave: nr 13, d.d. 30-09-2024

Bestelstaat Mavobox stekkenbak



Bedrijfsnaam: _____ Project: _____

Pos.	bak- type*	beugel- type*	Ø* mm	e mm	b mm	h mm	B mm	l _ü mm	h ₁ mm	b ₁ mm	baklengte mm	bakdikte** mm	aantal m	Uw opmerkingen
1.														
2.														
3.														
4.														
5.														
6.														
7.														
8.														
9.														
10.														

* Maak uw keuze uit het menu

** Minimale dikte N bak is 30 mm en TP/TW bak 35 mm

Altijd $b \leq B - 30$ mm. $b_{max} = 210$ mm, N-bakken: B = 60, 80, 110, 140, 160, 190, 220 of 240 mm. TP/TW-bakken: B = 110, 140, 160, 190, 220 of 240 mm.