

Bestelstaat stekkenbak met stalen deksel



Aanbevolen wordt de bestelstaat in te vullen met gebruik van Adobe Reader

Bedrijfsnaam: _____ Project: _____

Beugeltype D speciaal (Mavobox S)

Artikelcode:
1380 Ø 8
1381 Ø 10
1382 Ø 12

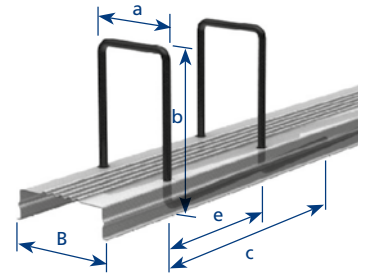
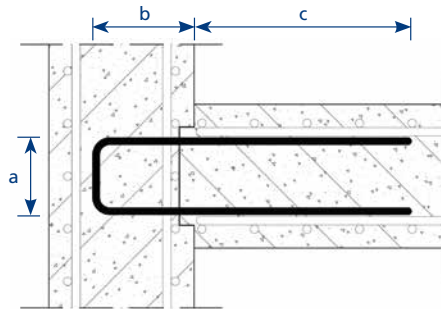

Beugeltype speciaal (Mavobox B)

Artikelcode:
1383 Ø 8, Ø 10 en Ø 12

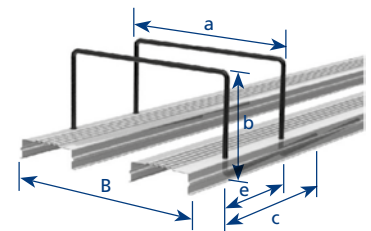
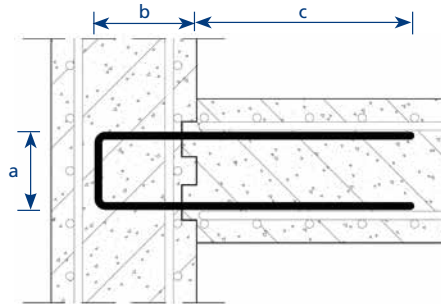

Beugeltype ES dubbel (Mavobox 2H)

Artikelcode:
1390 Ø 8
1391 Ø 10
1392 Ø 12

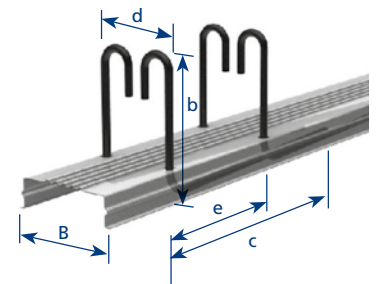
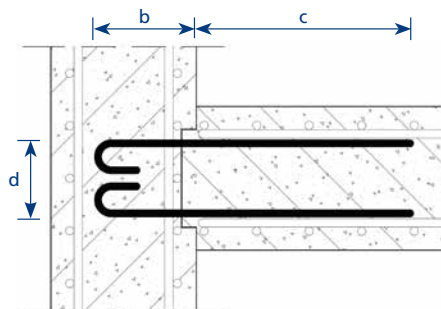

Beugeltype V dubbel (Mavobox 2W)

Artikelcode:
1393 Ø 8, Ø 10 en Ø 12

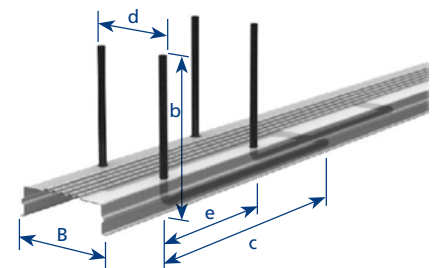
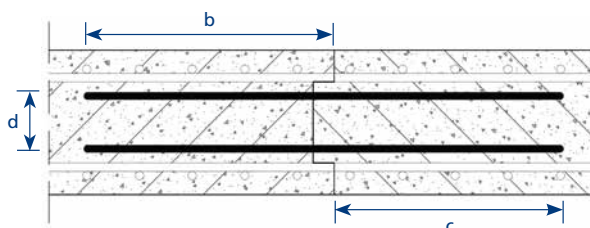

Aan deze documentatie kunnen geen rechten worden ontleend.
Wijzigingen voorbehouden.

Uitgave: nr 7, d.d. 27-11-2023

www.mavotrans.nl

Mavotrans - Storkstraat 25 - 2722 NR Zoetermeer
T. +31 79 344 63 63 - E. info@mavotrans.nl

Bestelstaat stekkenbak met stalen deksel

Bedrijfsnaam: _____ Project: _____

Beugeltype US (Mavobox WS)

Artikelcode:
1370 Ø 8
1371 Ø 10
1372 Ø 12

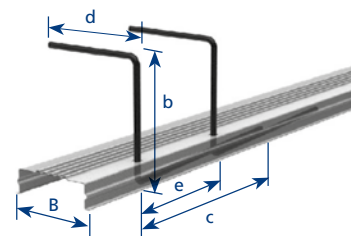
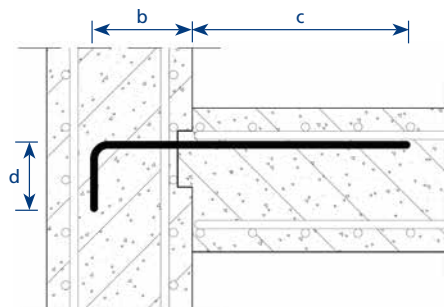

Beugeltype AS (Mavobox WH)

Artikelcode:
1373 Ø 8, Ø 10 en Ø 12

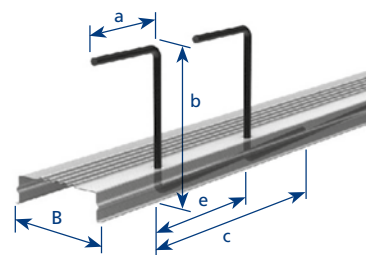
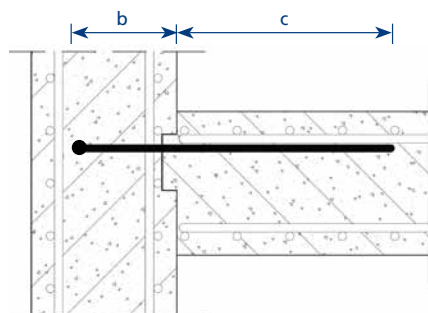

Beugeltype ES (Mavobox H)

Artikelcode:
1374 Ø 8, Ø 10 en Ø 12

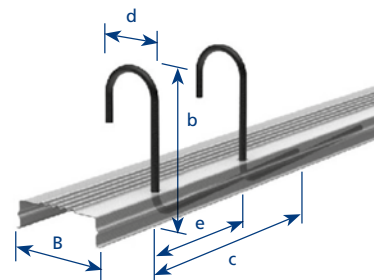
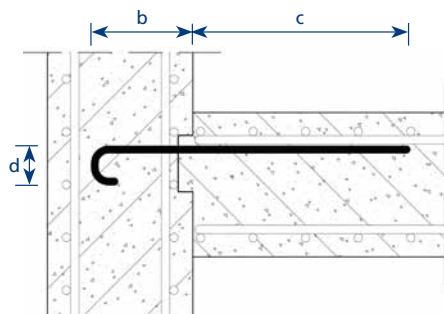

Beugeltype V (Mavobox W)

Artikelcode:
1375 Ø 8, Ø 10 en Ø 12

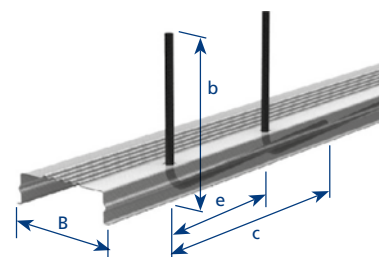
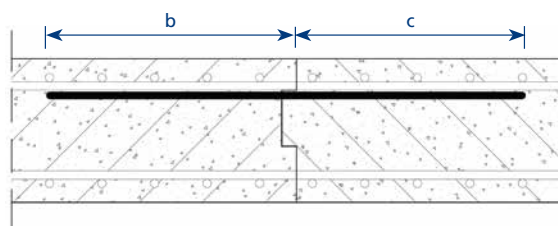

Aan deze documentatie kunnen geen rechten worden ontleend.
Wijzigingen voorbehouden.

Uitgave: nr 7, d.d. 27-11-2023

Bestelstaat stekkenbak met stalen deksel (voor nokken en penanten)

Bedrijfsnaam: _____ Project: _____

Beugeltype LS (Mavobox KO)

Artikelcode:
1386 Ø 8, Ø 10 en Ø 12

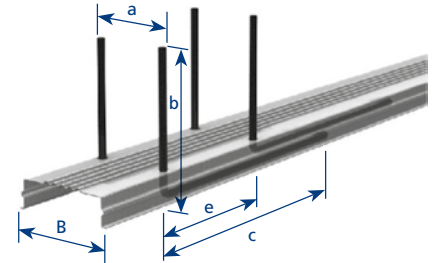
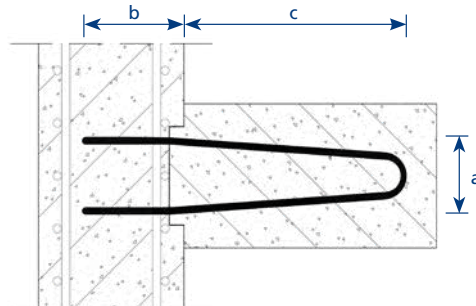

Beugeltype KS (Mavobox KH)

Artikelcode:
1387 Ø 8, Ø 10 en Ø 12

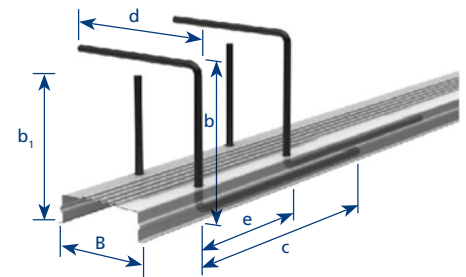
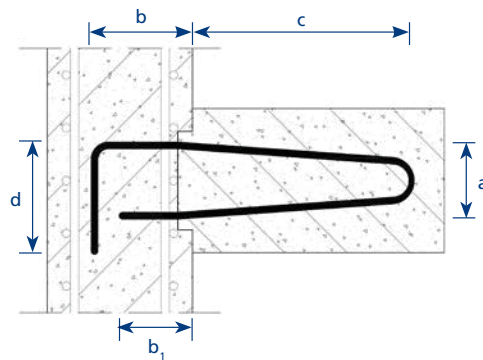

Indien u geen conisch gevormde staven wenst dan adviseren wij de Innogain stekkenbak.

Aan deze documentatie kunnen geen rechten worden ontleend.
Wijzigingen voorbehouden.

Uitgave: nr 7, d.d. 27-11-2023

www.mavotrans.nl

Mavotrans - Storkstraat 25 - 2722 NR Zoetermeer
T. +31 79 344 63 63 - E. info@mavotrans.nl

Bestelstaat stekkenbak met stalen deksel



Bedrijfsnaam: _____ Project: _____

Pos.	beugel- type*	Ø mm	e mm	a mm	b mm	B mm	c mm	b ₁ mm	d mm	baklengte mm	bakdikte** mm	aantal m	Uw opmerkingen
1.													
2.													
3.													
4.													
5.													
6.													
7.													
8.													
9.													
10.													
11.													
12.													
13.													
14.													
15.													
16.													
17.													
18.													
19.													
20.													
21.													
22.													
23.													

* Maak uw keuze uit het menu

** Standaard dikte bak is 30 mm, indien Ø 12 h.o.h. 100 mm dan is de bakdikte 40 mm

Als de e maat kleiner is dan de C maat, worden de beugels conisch uitgevoerd. Altijd $a \leq$ bakbreedte minus 30 mm, $b \max = 230$ mm, op aanvraag breder mogelijk
 $B \max = 260$ mm, op aanvraag breder mogelijk